



# User Manual



**Each Energy Technology (Suzhou) Co., Ltd.**

[www.eachenergy.com](http://www.eachenergy.com)

**Each Energy Technology (Suzhou) Co., Ltd.**

Address: No.8 Building, No. 38 of Beiguandu Road, Yuexi Street, Wuzhong District, Suzhou, Jiangsu Province, China

Tel: +8651266581088

Email: [service@eachenergy.com](mailto:service@eachenergy.com)

Web: [www.eachenergy.com](http://www.eachenergy.com)

## Copyright © Each Energy Technology (Suzhou) Co., Ltd.

Without written permission, any information of this document (partly or entirely) cannot be extracted, copied or transmitted in any form or by any means. All right reserved.

### Notice:

The information in this document is subject to change without notice. Please adhere to the actual products in case of any discrepancy. Any statements, description, and recommendations in this manual do not constitute a guarantee or warranty of any kind, explicitly or implicitly.

### Warranty:

Warranty terms and conditions can be downloaded from the Internet at [www.eachenergy.com](http://www.eachenergy.com).

## Contents

1. About the Manual .....	3
2. Product Overview .....	4
3. Safety .....	7
4. Mounting .....	8
4.1 Installation Location .....	8
4.2 Inverter Mounting .....	9
5. Electrical Connection .....	11
5.1 DC Side Connection of Inverters .....	11
5.2 AC Side Connection of Inverters .....	13
5.3 External Grounding Connection .....	14
5.4 Earth Fault Alarm .....	15
5.5 Over Current Protection Device .....	15
5.6 Communications Connection .....	16
5.7 Electrical Connection Overview .....	17
5.8 Meter and CT Installation (optional) .....	17
5.9 Residual Current Device (RCD) .....	19
5.10 DRM (Demand Response Mode) .....	19
6. Operation .....	20
6.1 Start and Stop Inverters .....	20
6.2 LCD Operation .....	21
6.2.1 Main Menu .....	21
6.2.2 Basic Info. ....	22
6.2.3 Basic Setup .....	23
6.2.4 Detail Info - Maintenance Personnel Only .....	24
6.2.5 Technical Set – Maintenance Personnel Only .....	29
7. Maintenance and Troubleshooting .....	42
8. Specification .....	48

## 1. About the Manual

The manual describes product information, mounting, installation, operation, maintenance, troubleshooting and specification of Each Energy inverters.

### Validity

The document is valid for the following inverter models: EES6KPro-M1, EES7K-M1, EES8K-M1, EES9K-M1 and EES10K-M1.

### Target Group

The target group of this manual are end users and qualified persons who have knowledge of inverters or skills of inverter installation, maintenance, etc. Only qualified persons are allowed to perform the installation and activities marked in this document under the guidance of safety instructions. Please read this manual carefully before conducting any kind of work on the inverters.

### Valid Region

This manual applies to the operation of Each Energy inverters in Australia, New Zealand, the UK, EU, South America, North America, and Southeast Asia.

## 2. Product Overview

### 2.1 Product Description

Each Energy EES6KPro-M1, EES7K-M1, EES8K-M1, EES9K-M1 and EES10K-M1 single phase on-grid inverters convert DC power generated by photovoltaic panel arrays into AC power and feed the converted AC power into utility grid.

### Product Appearance:

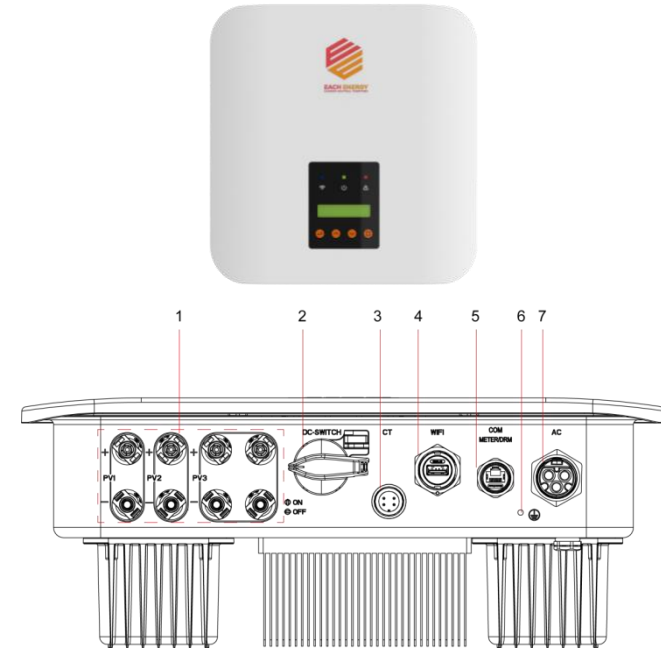

No.	1	2	3	4	5	6	7
Name	PV Input Ports	DC Switch	CT Port	Wifi/GPRS stick Port	COM/Meter/DRM Port	Grounding Port	AC Output Port

## 2.2 Front Panel

### Operation Panel:

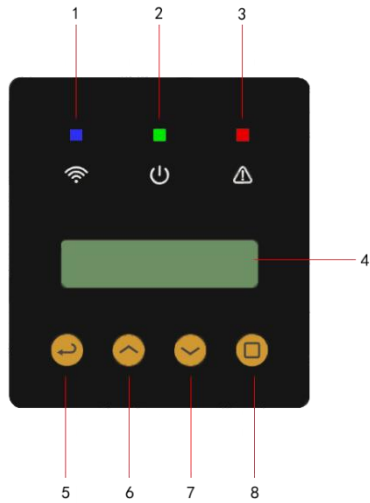

No.	1	2	3	4	5	6	7	8
Name	Communications Light	Power Light	Alarm Light	LCD	ESC	Up	Down	Enter

### LED Light:

Light	Status	Explanation
■ POWER	ON	The inverter is generating power
	OFF	The inverter is not generating power
■ COMMUNICATIONS	ON	The inverter has been connected to the Internet
	OFF	The inverter has not been connected to the Internet
■ ALARM	ON	Alarm or fault has been detected
	OFF	The inverter is operating normally



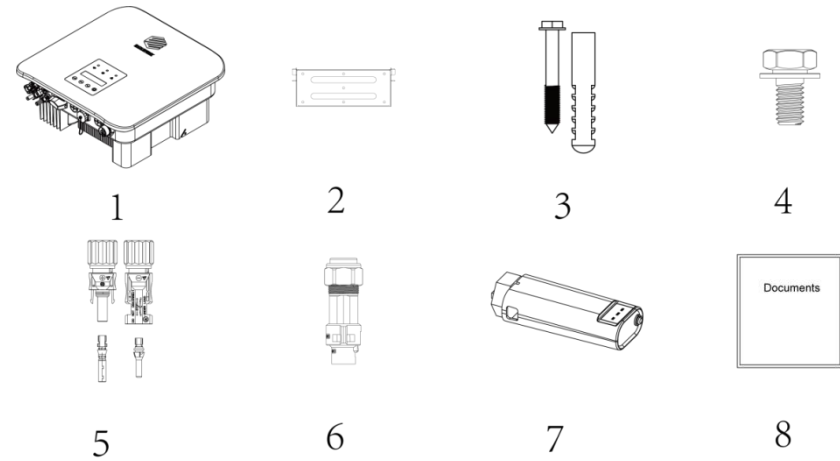



## 2.3 Scope of Delivery



No.	Description	Quantity
1	Inverter	1
2	Wall Bracket	1
3	Expansion Screws	3
4	Fastening Screws	2
5	DC Connectors	4 (pairs)
6	AC Connectors	1
7	WiFi/GPRS Stick	1
8	Documents	1

### 3. Safety

#### 3.1 Safety Symbols

Symbol	Explanation
 <b>DANGER</b>	Indicates a high level of risk which, if not avoid, may result in death or serious injury
 <b>WARNING</b>	Indicates a medium level of risk which, if not avoid, may result in death or serious injury
 <b>CAUTION</b>	Indicates a low level of risk which, if not avoid, may result in minor or moderate injury
 <b>NOTE</b>	Indicates a situation which, if not avoided, may result in device damage or property damage
 <b>ELECTRIC SHOCK</b>	Indicates a danger of electric shock or high voltage
 <b>HOT SURFACE</b>	Indicates hot surface, do not touch
 <b>WAIT</b>	Notice of waiting at least 5 minutes before operation

#### 3.2 Safety Instructions and Notice for Use

The inverters involved in this manual comply with applicable safety and technical regulations in design and test. To avoid personal injury and property damage and to ensure longer service life of the machines, please read this manual carefully and observe all safety information during operation.

Improper operation may result in risk of person injury or damage to the machine and to other property, so please ensure that the following requirements are met before or during operation.

- Installation of inverters must be performed by qualified technicians, and be in compliance with applicable electrical standards, regulations and the

requirements of local power authorities.

- Wear protective equipment for all work on the machines: helmet, insulated footwear, gloves, etc.
- Ensure that unauthorized persons and children have no access to the machines.
- Do not open the housing of the machines at any time. Unauthorized opening will void guarantee and warranty and may damage the machines.
- Do not touch non-insulated parts or cables, disconnect the machines from voltage sources and guarantee no possible re-connection before working on the machine.
- Use measuring devices with a DC input voltage range of 600 V or higher only.
- High voltage is present in the live parts and cables inside the product during operation, wait at least 5 minutes after disconnecting voltage sources.
- The temperature of some parts of the inverter may exceed 60 °C during operation. To avoid being burnt, do not touch the inverter during operation.
- Pack inverters properly during transportation, and do not transport them together with flammable material.

### 4. Mounting

#### 4.1 Installation Location



#### **WARNING**

Do not select locations storing flammable material which may cause fire or explosion!

The following points should be considered when selecting an installation location.

- The wall bearing inverters shall be able to hold the weight of at least 4 times of the weight of the inverters.
- The location shall be convenient for electrical connection, operation and maintenance.
- The ingress protection of the inverter is IP66, so it can be installed both indoors and outdoors.
- The temperature of the cooling fin may exceed 75 °C, so select safe locations.
- The location must be well ventilated and sheltered from direct sunlight, rain or snow.
- Ensure the visibility of the LED lights and LCD display on the front panel of inverters.
- Install inverters vertically or with a backward tilt within 15 degrees. No lateral tilt is allowed.
- If more than one inverter are installed in one location, a minimum 150 mm clearance should be kept between two inverters and a minimum 300 mm clearance between inverters and the ground.

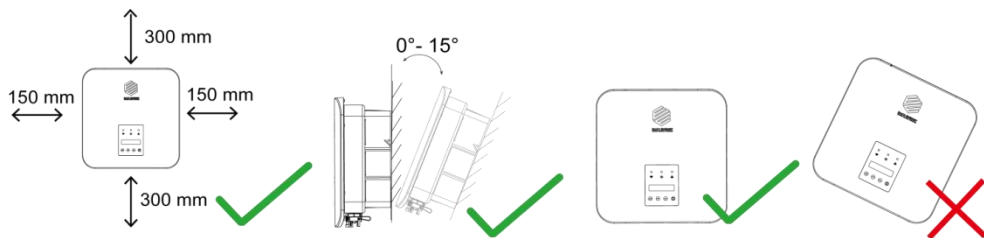

- The Inverter is to be installed in a high traffic area where the fault is likely to be seen.

## 4.2 Inverter Mounting

Dimension of the mounting bracket:

Unit: mm

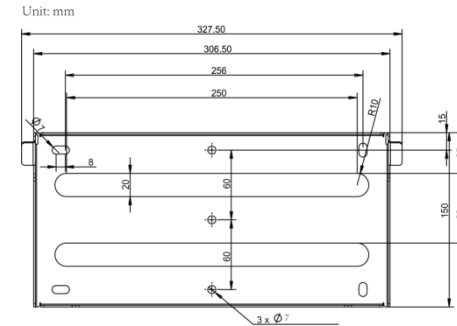

### Procedures:

- 1) Ensure that the bracket is horizontal. Mark the position of the drill holes. For brick walls, the position of the holes should suit expansion screws.
- 2) Use a 10 mm drill bit to drill mounting holes of 40 mm deep.
- 3) Insert the expansion tubes into holes.
- 4) Screw the expansion screws into expansion tubes with a cross screwdriver to fix the bracket on the wall.

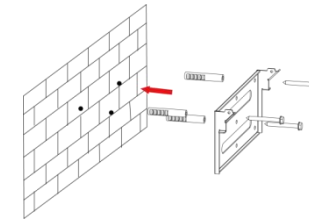

- 5) Lift up the inverter, and hang it on the mounting bracket securely.
- 6) Lock the inverter to the mounting bracket with screws.

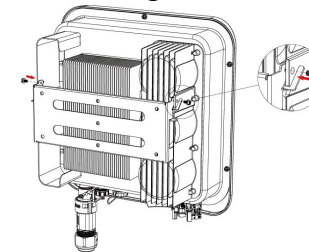

**NOTE:** To protect your hands from scratch, please wear gloves!

## 5. Electrical Connection

### 5.1 DC Side Connection of Inverters



#### **DANGER ELECTRICAL SHOCK**

Lethal high voltage will be generated by PV arrays under sunlight, so please disconnect DC and AC breakers and ensure no possibility of re-connection before conduct electrical connection!

PV strings should be connected to the inverter through special PV connectors that are in the scope of delivery.



**NOTE:** Use only the supplied connector or the connector with IP 65 or above to guarantee that the protection ingress of the whole inverter is IP66!

It is recommended to use the DC cable of 4 or 6 mm<sup>2</sup>.



**NOTE:** Use DC cables specialized for photovoltaic systems Only!

#### **Assemble DC cables to DC connectors:**

- 1) Strip the insulation layer off the DC Cable for about 7mm.
- 2) Insert the wire into the Crimp Contact and crimp them with an electrical crimp-er.

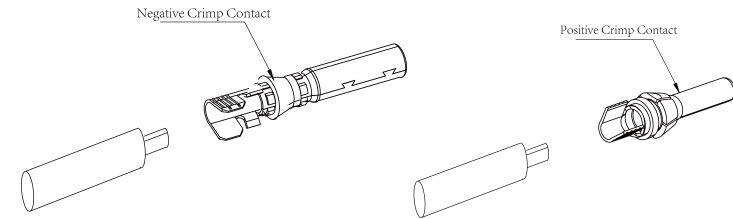

- 3) Thread the cable through the Cable Gland, insert it into the insulator, and gently pull backward the cable to ensure firm connection. Then screw up the Cable Gland to the Insulator.

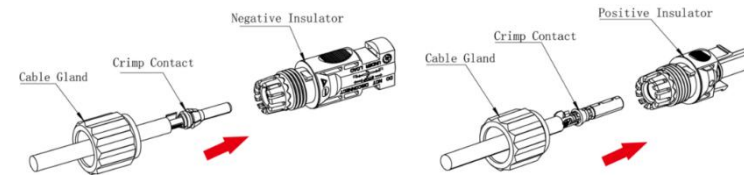

#### **Install the DC connectors to the Inverter:**

- 1) Turn the Grid Supply Main Switch OFF.
- 2) Turn the DC switch OFF.
- 3) Connect the DC connectors to the Inverter, small click confirms connection. Please guarantee the correct polarity of the connection.



#### **WARNING**

Ensure that the open circuit voltage of PV array is within the max. input voltage of the inverter!



**WARNING:** Do not turn off DC switch directly for accident reverse connection of DC inputs or any fault of inverters as it may damage inverters. In that case, turn off the DC switch only when the DC current is below 0.5 A.

## 5.2 AC Side Connection of Inverters

When connecting an inverter to the utility grid, please use 4 – 6 mm<sup>2</sup> outdoor cable. For Each energy 3 KW to 4 KW inverters, it is recommended to use 4 mm<sup>2</sup> cable, and for 5 KW to 6 KW inverters, use 6 mm<sup>2</sup> cable.

An AC Connector is supplied together with the inverter.

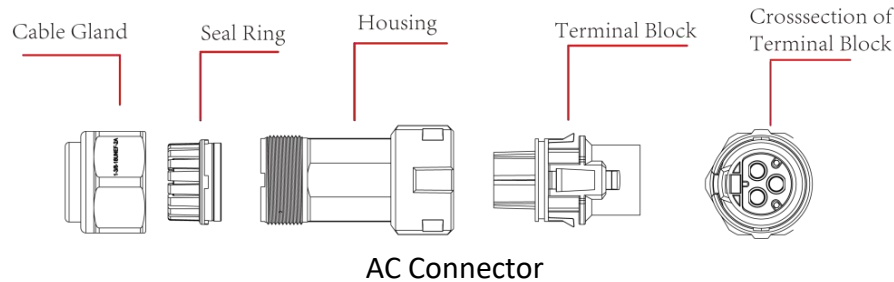

### Procedures:

- 1) Strip the insulation layer off the AC cable about 8 to 15 mm.

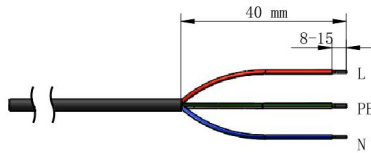

- 2) Thread the AC cable through the Cable Gland and the Housing.
- 3) Connect wires to the Terminal Block:

insert yellow green wire to the grounding (PE) terminal, red or brown to live line (L) terminal and blue or black to zero line (N) terminal; screw up screws on the connectors with socket head wrench and pull back wires to ensure firm connection.



**WARNING:** The external grounding connection cannot replace the connection of PE terminal in AC connection. Ensure that both the external grounding connection and the PE connection are done properly!

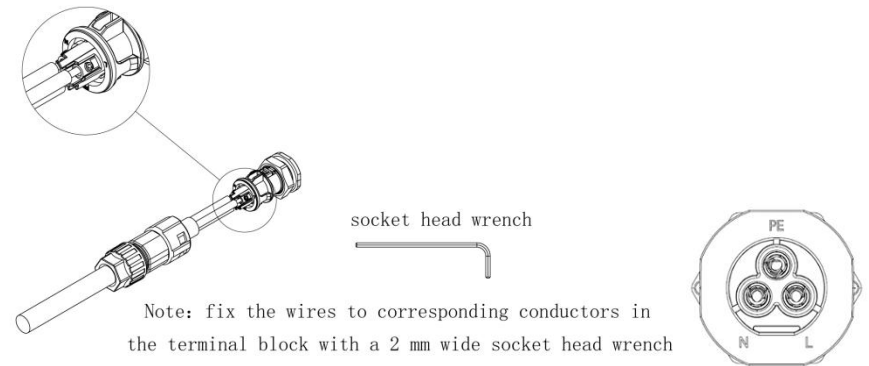

- 4) Connect the Cable Gland, Seal Ring, Housing and Terminal Block together, a small click confirms secure connection.
- 5) Connect the AC connector to the inverter, a small click confirms connection.

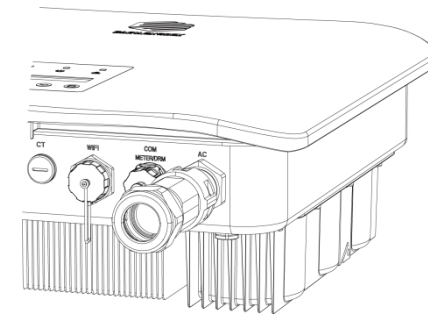

## 5.3 External Grounding Connection

The external grounding port is located beside the AC connection terminal of the inverter.

### Procedures:

Prepare an OT terminal M4, crimp a grounding cable to the terminal, insert a fastening screw into the OT terminal, insert them to the grounding port on the inverter, and screw them tightly (the torque is 2 N.m.).



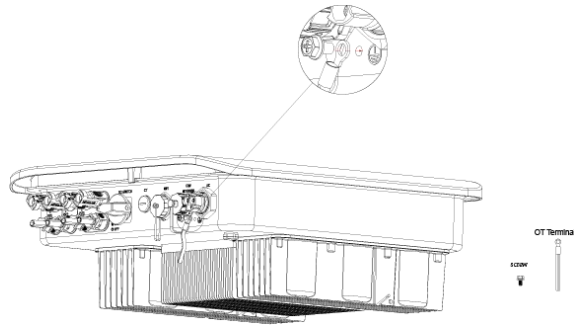

### 5.4 Earth Fault Alarm

The inverters are designed with an earth fault alarm function. If an earth fault occurs, the inverters will stop generating power, the red alarm light will be on and the LCD will display 'ISO Out Range' or 'PEN No Connect'. In that case, please refer to Chapter 7 for troubleshooting or contact Each Energy for help.

### 5.5 Over Current Protection Device

It is recommended to install a breaker (over current protection device (OCPD)) to protect the AC grid connection conductors. The table below is the recommended parameter of an OCPD ratings for the Inverter.

Inverter	Rated output voltage (V)	Rated output current (A)	Current for protection device (A)
EES6KPro-M1	230	26.0	32
EES7K-M1	230	30.4	40
EES8K-M1	230	34.8	40
EES9K-M1	230	39.1	50
EES10K-M1	230	43.5	50

## 5.6 Communications Connection

### 5.6.1 Communications overviews

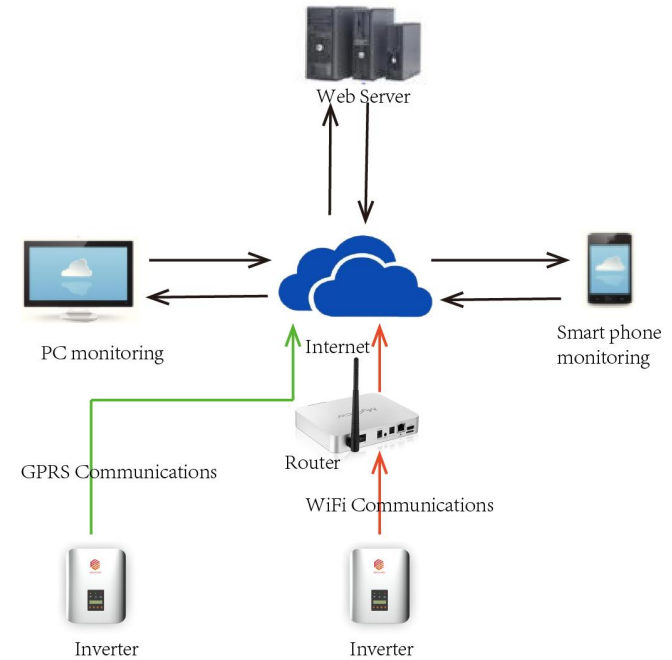

### 5.6.2 WiFi/GPRS Stick Installation

Assemble WiFi/GPRS stick to the corresponding port on inverter as shown in the diagram.

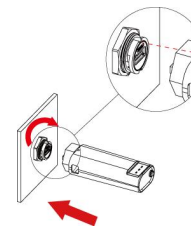

- 1) Plug the stick to the Wifi port on the inverter
  - 2) Rotate the front operative part of the stick clockwise till the secure connection of the stick
- More detailed information about communications can be found in corresponding manuals.

## 5.7 Electrical Connection Overview

The following is a diagram of a typical solar system for your reference to install inverters.

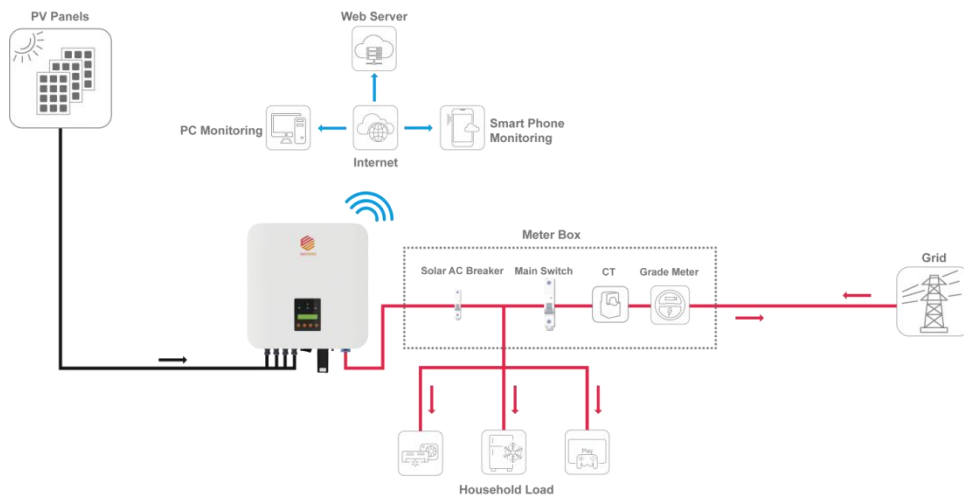

## 5.8 Meter and CT Installation (optional)

A meter and CT (current transformer) can be connected to corresponding ports on inverter to monitor electricity parameters such as current, voltage, power, etc. and to realize export power management.

The suggested parameter:

Max input current for meter: 120A

Max measuring current for CT: 100A

Detail specifications of meter and CT can be found on Each Energy Website and a customer can purchase a suitable meter and CT for inverters on the website.



### NOTE

No need to change any parameter of the meter as it has been preset in the factory!

### Meter and CT connection:

For more information about meter and CT connection, please refer to corresponding manuals on Each Energy website.

The following is schematic diagrams for reference.

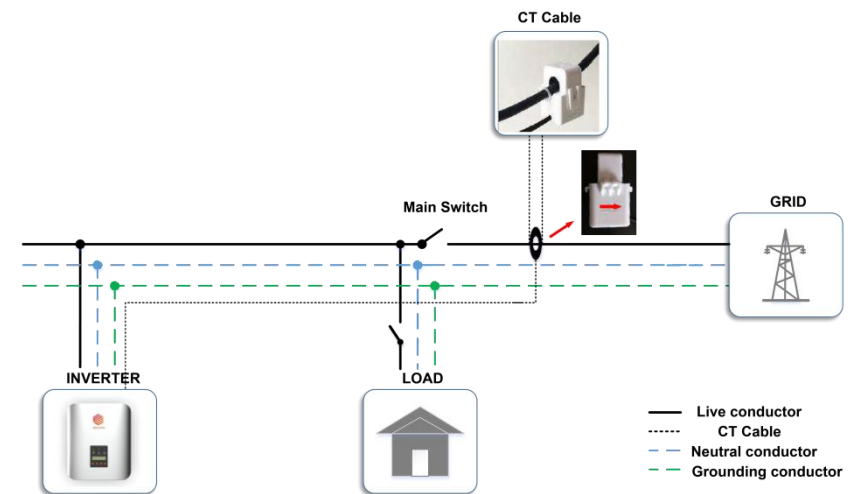

CT Installation Electrical Diagrams



### DANGER ELECTRICAL SHOCK

Turn off upstream and downstream electrical connection before the meter installation!

## 5.9 Residual Current Device (RCD)

An internal residual current device is integrated in the inverter to protect against any potential residual current. If the residual current that exceeds a set limit is detected, the inverter will stop working, the warning light will be on and the LCD will display 'GFCI Device Fault' or 'GFCI Out Range'.

If you need to install an external RCD as required by local grid company, we suggest a Type-A RCD with a threshold current higher than 100 mA.

## 5.10 DRM (Demand Response Mode)

The DRM port is only applicable to installations in Australia and New Zealand as requires by the standard of AS/NZS 4777.2:2020. The inverter detects and initiates a response to the demand response modes listed in the following table.

Mode	Functions
DRM 0	Operate the disconnection device
DRM 5	Do not generate power
DRM 6	Do not generate at more than 50 % of rated power
DRM 7	Do not generate at more than 75 % of rated power AND absorb reactive power if capable
DRM 8	Increase power generation (subject to constraints from other active DRMs)

Ways to connect a DRED (demand response enabling device) to inverters

- 1) Assemble a RJ45 connector by connecting a network cable to the RJ45 according to the international conventional method;
- 2) Plug the RJ45 connector to the DRM port of the inverter.

Power rate limit modes as required by AS/NZS 4777.2:2020 is supported in this inverters. When a demand response mode (except for DRM 0) is asserted or unasserted the power rate limit will apply to the increase or decrease in power generation or consumption and the transitions between power levels.

When a DRED is connected to an inverter, the inverter will receive and response to the outside signal directly. And the DRM working mode will be shown in the BASIC INFO in the LCD menu.

## 6. Operation

### 6.1 Start and Stop Inverters

#### 6.1.1 Inverter Turning-on

The following procedures have to be followed exactly to start an inverter.

- 1) Turn on the AC breaker.
- 2) Turn on the DC Switch.
- 3) After a compulsory delay of 30 to 300 seconds, the inverter will start to work and the POWER light will be on.



#### **WARNING**

Ensure that the open circuit voltage of PV array is within the max. input voltage of the inverter!



#### **DANGER ELECTRIC SHOCK**

High voltage may present, please beware of the risk of electric shock and take protection precautions!

#### 6.1.2 Inverter Turning-off

The following procedures have to be followed exactly when stop an inverter.

- 1) Switch off the AC Switch.
- 2) Wait around 30 seconds for the capacitor to dissipate energy. Then turn the DC switch OFF.
- 3) Be sure that all LED light is OFF (around 1 minute).



**CAUTION WAIT**

Beware of the risk of electrical shock! Wait at least 5 minutes before touching the machine although the DC switch has been turn off!

## 6.2 LCD Operation

### 6.2.1 Main Menu

When the inverter has been started, the LCD screen shows operation status and power of the inverter alternately every 10 seconds (refer to below figure). You can press UP and DOWN keys to scroll the screens and press ENTER key to access the main menu. The main menu includes four sub-menus: BASIC INFO, BASIC SETUP, DETAIL INFO, and TECHNICAL SET.

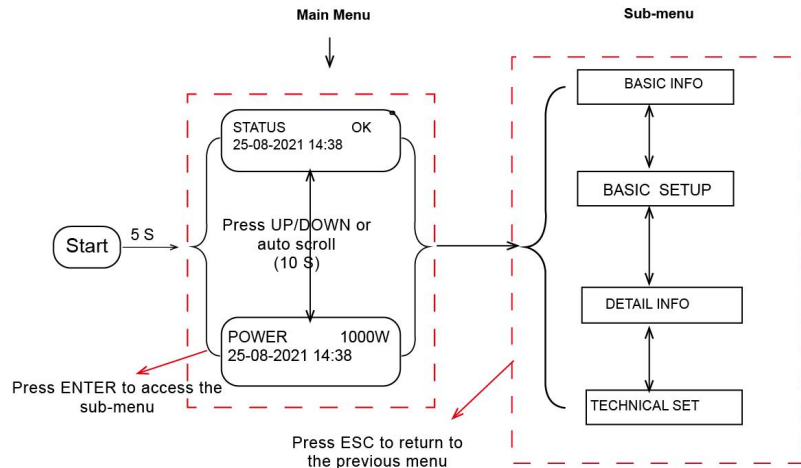

### 6.2.2 Basic Info.

The table below explains the meaning of information displayed in the sub-menu of Basic Info.

No.	Displays	Duration	Explanation
1	TOTAL ENERGY 50000 Kwh	10 S	Total energy: total energy generated
2	ThisMon: 255Kwh LastMon: 254Kwh	10 S	This Month: total energy generated this month Last Month: total energy generated last month
3	TODAY: 52 Kwh PRE DAY : 54Kwh	10 S	This Day: total energy generated today Previous Day: total energy generated yesterday
4	DC VOL1: 401.5V DC CUR1: 18.6A	10 S	DC voltage1: the DC voltage of the PV input 1 DC current1: the DC current of the PV input 1
5	DC VOL2: 408.5V DC CUR2: 18.6A	10 S	DC voltage2: the DC voltage of the PV input 2 DC current2: the DC current of the PV input 2
6	DC VOL3: 408.5V DC CUR3: 18.6A		DC voltage3: the DC voltage of the PV input 3 DC current3: the DC current of the PV input 3

7	AC VOL: 230.6V AC CUR: 38.8A	10 S	AC voltage: the voltage of the utility grid AC current: the current of the utility grid
8	GRID FREQ:50.2Hz POWER : 1000 W	10 S	Frequency: the frequency of the utility grid Output Power: 1000 W
9	TOTAL RUNTIME: 152 H	10 S	Cumulative energy generation time
10	INVERTER SN EE00S005000001A1	10 S	Inverter SN: The SN of the Inverter EE00S005000001A1
11	MODLE: Volt-Watt	10 S	Working Mode: DRM(Demand response mode) Number:
12	Standard cAusas4777 2A	10 S	This menu indicates the current country grid code or safety standards selected

Users are able to view those info without password including country grid code. cAUSAS4777\_2A, cAUSAS4777\_2B, cAUSAS4777\_2C and cNZS4777\_2 represent Australia A, Australia B, Australia C and New Zealand standard respectively.

### 6.2.3 BASIC SETUP

You can set time and address in this sub-menu.

No.	Display	Explanation
1	SET TIME	To set up time

2	SET RS485 ADDR	To set up RS485 address
3	SET LANGUAGE	To set up language

#### 6.2.3.1 Time Setting-up

When the sub-menu of 'SET TIME' is selected, the LCD will display the screen as below.

NEXT = ENT OK = ESC  
25-01-2022 18:23

Press ENT to move the cursor from left to right, Press UP/DOWN to select a number for a selected digit. Press ESC to save the setting and return to the main menu.

#### 6.2.3.2 Address Setting-up

The inverter RS 485 address communicating with a monitoring platform can be set here, the address ranges from '01' to '99', and the default address is '01'.

YES = ENT EXIT = ESC  
Slave Add: 01

Press UP/DOWN to scroll through numbers for a selected digit, press ENT to save the setting and return to the main menu, and press ESC to return to the main menu without saving the setting.

#### 6.2.3.3 Language Setting-up

Working language of the inverter can be set here, and the default language is English.

### 6.2.4 Detail Info - Maintenance Personnel Only

Select 'Detail Info' from the main menu and the LCD screen will display the following information:

NEXT = ENT EXIT = ESC  
 Password: 0000

### Steps to view the menu of the Detail Info.:

1) Enter the password:

Please contact your inverter supplier for the default password. When finishing password entering, press ENT to verify the password. If the password is correct, the sub-menu will be displayed, and if wrong, the LCD will display 'Wrong Password' and return to the previous menu. Press ESC to return to the main menu.

2) Access the sub-menu:

After enter the correct password, the 6 sub-menus will be displayed:

**1. Operation Info, 2. Fault Info, 3. Warning Info, 4. SW Version, 5. Rated Power, 6. Rated Voltage, 7. Daily Energy, 8. Monthly Energy, 9. Yearly Energy, 10. Export Total, 11. Export Today**

Press UP/DOWN to scroll the screen, press ENT to go into the selected sub-menu and press ESC to return to the main menu.

#### 6.2.4.1 Operation Information

This information is for maintenance personnel to get the operation information, and the information is as below:

No.	Display	Duration	Explanation
1	GFCI RMS: 10 mA ISO : 1.25 kΩ	10 S	This menu indicates: GFCI RMS: Leakage current protection ISO: Ground fault protection/Insulation Resistance

2	Heatsink Temp 65.5 °C	10 S	This menu indicates: The temperature of heat sink of inverters
3	Inv Inner Temp 45.0 °C	10 S	This menu indicates: Inverter inner temperature
4	BusVol: 385.5V DCI : 0 mA	10 S	This menu indicates: Bus voltage AC direct component
5	PF:+1.00 ac Pac Limit: 80%	10 S	This menu indicates: Power factor ratio Output power limit
6	RCD(GFCI): ON PVISOGuard: ON	10 S	This menu indicates: Residual current protection Insulation Resistance/Ground fault protection
7	AllPVParal: ON MPPTShadow:	10 S	This menu indicates: All PV in parallel mode MPPT shadow mode
8	RelayCheck:OFF DCI Prot : ON	10 S	This menu indicates: Self examination of AC relay Output direct component protection
9	Apparent Power 2000 VA	10 S	This menu indicates the apparent power
10	Active Power 2000 W	10 S	This menu indicates the active power
11	Reactive Power 2000 Var	10 S	This menu indicates the reactive power

12	Export Power 4800W	10 S	This menu indicates the power exported to grid
----	-----------------------	------	--

The operation info of inverter and part of protection info. can be view after password has been input and all the info. is included in the above table. Press UP/DOWN to scroll the screen to view.



**NOTE:** This operation is for maintenance personnel only. Password is required to access this part! Please reset the password at the first operation.

#### 6.2.4.2 Fault Info.

When a fault happens, the Alarm Light will be on, and the LCD will display a brief description of the fault. Please refer to Chapter 7 for troubleshooting or contact after-sales department if a fault info. is displayed.

ACHCT Device  
Fault

#### 6.2.4.3 Warning Info.

If a adverse condition presents in the inverter, the LCD will display a warning information. The inverter will work normally with such warning conditions. When a warning info. is displayed, please refer to Chapter 7 for troubleshooting.

Warning Info  
0x00000400

#### 6.2.4.4 Software Version/Firmware Version

The software version or firmware version of the inverter is displayed and is accessible for technicians only.

SW Version  
V01.05

#### 6.2.4.5 Rated Power

The rated power of the inverter is displayed here.

Rated Power  
5KW

#### 6.2.4.6 Rated Voltage

The rated voltage of the inverter is displayed here.

Rated Voltage  
220V

#### 6.2.4.7 Daily Energy

The energy generated for a specified day can be checked here.

Select Day  
2020-02-22

#### 6.2.4.8 Monthly Energy

The energy generated for a specified month can be checked here.

Select Month  
2020-02-22

#### 6.2.4.9 Yearly Energy

The energy generated for a specified year can be checked here.

Select Year  
2020-02-22

#### 6.2.4.10 Export Total

Total energy exported to grid can be checked here.

Export Total  
500KWh

#### 6.2.4.11 Export Today

The energy exported to grid today can be checked here.

Export	Today
10.2KWh	

### 6.2.5 Technical Set – Maintenance Personnel Only

This section is for maintenance personnel only, enter password to access the sub-menu as guided by Chapter 6.2.4.

The sub-menu:

No.	Display	Explanation
1	ALL Set Enable	To enable the setting-up of all functions under the menu of Technical Set
2	Standard Set	To set up safety standard or country grid code for the inverters
3	VAC H Limit	To set up the high limit of AC output voltage
4	VAC L Limit	To set up the low limit of AC output voltage
5	FAC H Limit	To set up the high limit of AC output frequency
6	FAC L Limit	To set up the low limit of AC output frequency

7	Pmax Limit	To set up the max generation power
8	AC Inst Limit	To set up the AC instant voltage limit
9	Power Control	To set up the power control
10	Standard Func	To set up the increase power rate limit and decrease power rate limit
11	Special Func	To set up special functions
12	Set Passwords	To set up passwords
13	Factory Reset	To restore factory settings
14	Adjust Total E	To adjust the total power generated
15	Reset Total E	To clear the power generation record
16	Inverter ON/OFF	To turn on or turn off inverters



17	Export Limit	To set up export power limit
----	--------------	------------------------------

Press UP/DOWN to scroll the menu, press ENT to access the sub-menu, and press ESC to return to the previous menu.

 **NOTE:** This part is accessible for qualified and accredited technicians only!

### 6.2.5.1 All Set Enable

This function is to enable all the setting-up functions under the menu of 'Technical Set'. Before enabling or setting up any of the function under this menu, please turn the 'All Set Enable' on.

ALL SET Enable  
ON

### 6.2.5.2 Standards Set

The safety standard for different countries can be selected in this sub-menu.

Standard Set  
cAusas4777\_2A

Australia A, Australia B, Australia C and New Zealand grid codes can be selected here. cAUSAS4777\_2A, cAUSAS4777\_2B, cAUSAS4777\_2C and cNZS4777\_2 represent Australia A, Australia B, Australia C and New Zealand standard respectively.

#### Procedures:

Step1: go to 'All Set Enable' in the menu of 'TECHNICAL SET' and turn the status to 'ON'.

Step2: move to 'Standard Set' and get inside

Step3: select the country grid code needed.

Press UP/DOWN to scroll through the national standards, press ENT to

confirm the safety standard, and press ESC to return to the previous menu.

 **NOTE:** This operation is for maintenance personnel only. Password is required to access this part!

### 6.2.5.3 AC Output Voltage Limit

This section is to set up the high and low limit of AC output voltage as permitted by local grid company if the grid voltage is beyond the range specified by national standards.

VAC H Limit Set  
270V

VAC L Limit Set  
180V

The detailed procedure is described in a separated document named 'Voltage Adjustment'.

### 6.2.5.4 AC Output Frequency Limit

This section is to set up the high and low limit of AC output frequency as permitted by local grid company if the grid frequency is beyond the range specified by national standards.

FAC H Limit Set  
52Hz

FAC L Limit Set  
47Hz

The method to set up the AC output frequency limit is similar to that of AC voltage adjustment.

### 6.2.5.5 Max Generation Power Setup

The max output power can be set up here.

Pmax Limit  
70% of Prated

The detailed procedure to set up the Max generation power is described in a separated document named 'Power Generation Limit'.

### 6.2.5.6 Power Control

No.	LCD Display	Explanation
1	Q Set +60%	To set up reactive power
2	PF Set +80%	To set up power factor
3	Q Reset  YES=ENT EXIT=ESC Are You Sure?	To restore reactive power
4	PR Reset  YES=ENT EXIT=ESC Are You Sure ?	To restore power factor

Reactive power and power factor can be set up and restored here.

The power quality response modes as required by the standard of AS/NZS 4777.2:2020 can be activated or controlled under this menu combined with the menu of special function. The detail procedure will be described in the following part.

#### 6.2.5.7 Standard Function

Power increase slope and decrease slope can be set up here.

Pwr UpSlope 90%	Pwr DownSlope 20%
--------------------	----------------------

This part is for the setup of power rate limit modes as required by AS/NZS 4777.2:2020. Soft ramp up after connect, reconnect or soft ramp up/down following a response to frequency disturbance is available in those inverters.

#### Procedures to set up the gradient of power rate limit:

Step1: Go to 'All Set Enable' in the menu of 'TECHNICAL SET' and turn the status to 'ON'.

Step2: Go to 'Standard Func' and then get inside.

Step3: Go to set up the 'Pwr UpSlope' or 'Pwr DownSlope' for the soft ramp up/down of rated power per minute.



**NOTE:** This operation is for maintenance personnel only. Password is required to access this part!

#### 6.2.5.8 Special Function Setup

No.	LCD Display	Explanation
1	Set CV MPPT	To set up the constant PV voltage
2	All PV Paral	To set up the multiple MPPTs parallel mode
3	HVRT	To enable the High Voltage Ride Through
4	LVRT	To enable the Low Voltage Ride Through
5	1/2BUS Prot	To enable the bus mid-point voltage protection

6	DCI Prot	To enable the DC component inspection
7	GFCI Prot	To enable the GFCI protection
8	ISO Prot	To enable the ISO protection
9	Island Prot	To enable the island protection
10	Buzzer Enabled	To enable the buzzer
11	Relay Check	To enable the relay
12	QU CURVE	To enable the QU curve
13	PF CURVE	To enable the PF curve
14	Q CURVE	To enable the Q curve
15	PU CURVE	To enable the PU curve

16	Shadow MPPT:	To enable the shadow MPPT mode
----	--------------	--------------------------------

#### 6.2.5.8.1 Island Protection

The active anti-islanding protection of the inverters is achieved by shifting the frequency of the inverter away from nominal conditions in the absence of a reference frequency (frequency shift). It is enabled by default.

#### 6.2.5.8.2 Volt-var Response Mode

QU CURVE ON

The QU Curve is enabled by default. The volt-var response mode changes the reactive power absorbed or supplied by the inverter in response to the voltage at its grid-interactive port. The diagram and table below are the response mode required for the volt-var response according to the standard of AS/NZS 4777.2:2020.

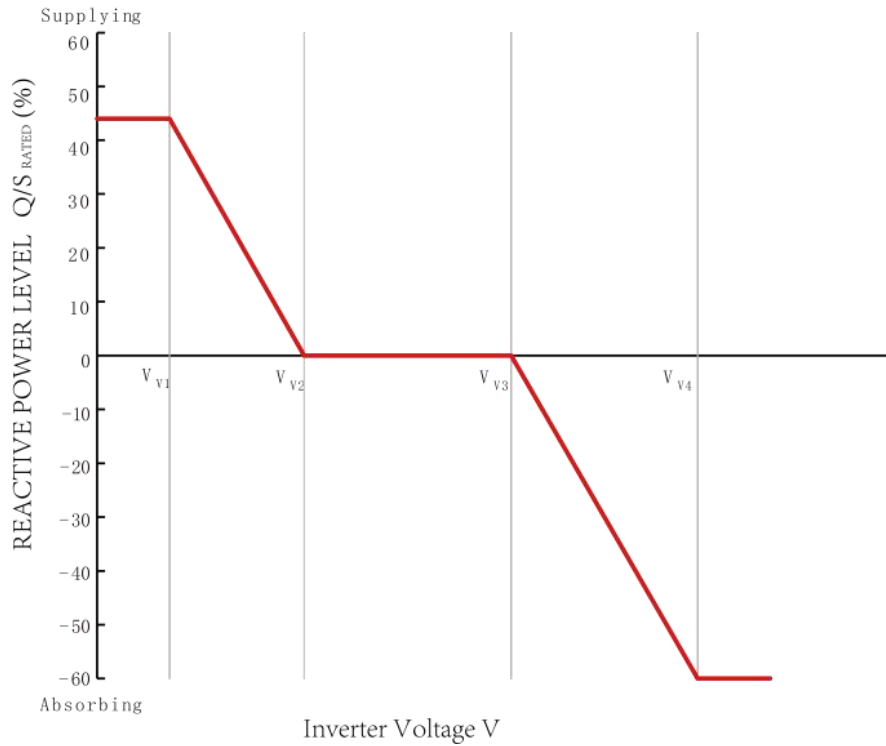

Region	Default Value	$V_{V1}$	$V_{V2}$	$V_{V3}$	$V_{V4}$
Australia A	Voltage	207 V	220 V	240 V	258 V
	Inverter reactive power level (Q)% of $S_{rated}$	44% supplying	0%	0%	60% absorbing
Australia B	Voltage	205 V	220 V	235 V	255 V
	Inverter reactive power level (Q)% of $S_{rated}$	30% supplying	0%	0%	40% absorbing
Australia C	Voltage	215 V	230 V	240 V	255 V

	Inverter reactive power level (Q)% of $S_{rated}$	44% supplying	0%	0%	60% absorbing
New Zealand	Voltage	207 V	220 V	235 V	244 V
	Inverter reactive power level (Q)% of $S_{rated}$	60% supplying	0%	0%	60% absorbing

### Procedures to enable or disable the Volt-var Response Mode:

Step1: go to 'All Set Enable' in the menu of 'TECHNICAL SET' and turn the status to 'ON'.

Step2: go to 'Special Func' and then go to 'QU Curve'

Step3: enable or disable the 'Volt-var Response Mode' by changing the status to 'ON' or 'OFF'.



**NOTE:** This operation is for maintenance personnel only. Password is required to access this part!

### 6.2.5.8.3 Volt-watt Response Mode

PU CURVE ON

The PU Curve is enabled by default. The volt-watt response mode varies the maximum active power output level of the inverter in response to the voltage at its grid-interactive port. The diagram below is the response curve required for the volt-watt response according to the standard of AS/NZS 4777.2:2020.

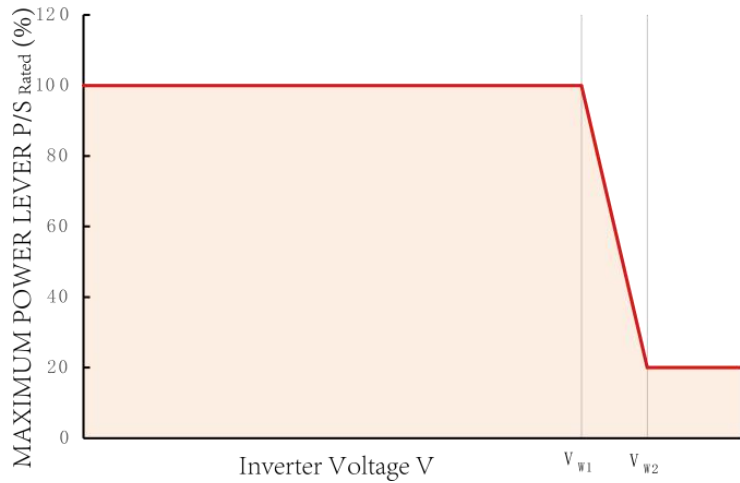

Region	Default Value	$V_{w1}$	$V_{w2}$
Australia A	Voltage	253 V	260 V
	Inverter maximum active power output level (P)% of $S_{rated}$	100%	20%
Australia B	Voltage	250 V	260 V
	Inverter maximum active power output level (P)% of $S_{rated}$	100%	20%
Australia C	Voltage	253 V	260 V
	Inverter maximum active power output level (P)% of $S_{rated}$	100%	20%
New Zealand	Voltage	242 V	250 V
	Inverter maximum active power output level (P)% of $S_{rated}$	100%	20%

**Procedures to enable or disable the Volt-watt Response Mode:**

Step1: go to 'All Set Enable' in the menu of 'TECHNICAL SET' and turn the status to 'ON'.

Step2: go to 'Special Func' and then go to 'PU Curve'

Step3: enable or disable the 'Volt-watt Response Mode' by changing the

status to 'ON' or 'OFF'.



**NOTE:** This operation is for maintenance personnel only. Password is required to access this part!

**6.2.5.8.4 Fixed Power Factor Mode or the Reactive Power Mode**

PF CURVE    OFF

Q CURVE    OFF

Those modes are disabled by default. The fixed power factor mode or the reactive power mode may be enabled in some situations by the electrical distributor to meet local grid requirements, one of these modes shall be enabled if the volt-var mode is disabled.

**Procedures to set up the Reactive Power Mode:**

Step1: go to 'All Set Enable' in the menu of 'TECHNICAL SET' and turn the status to 'ON'.

Step2: go to 'Special Func', then go to 'Q Curve' and enable the Q Curve by change the status to 'ON'

Step3: go to 'Power Control' and then go to 'Q Set'.

Step 4: Set up the Reactive Power Mode manually.

**Procedures to set up the Fixed Power Factor Mode:**

Step1: go to 'All Set Enable' in the menu of 'TECHNICAL SET' and turn the status to 'ON'.

Step2: go to 'Special Func', then go to 'PF Curve' and enable the PF Curve by change the status to 'ON'

Step3: go to 'Power Control' and then go to 'PF Set'.

Step 4: Set up the Fixed Power Factor manually.



**NOTE:** This operation is for maintenance personnel only. Password is required to access this part!

### 6.2.5.9 Password Set-up

The password for 'Detail Info' and 'Technical Set' can be reset here.

```
Password: 1100
Confirm: 1100
```

Press ENT to move the cursor, press UP/DOWN to select a number for a digit selected, and press ENT to confirm the setup after the last digit has been set up. Press ESC to return to previous menu.

### 6.2.5.10 Factory Reset

This function is designed to restore factory defaults.

```
YES=ENT EXIT=ESC
Are You Sure ?
```

### 6.2.5.11 Adjust Total E

The total energy generated may be cleared or changed after maintenance or translocation, and the previous data can be restored with this function. The total energy generated can be adjusted here.

```
TOTAL ENERGY
5700000 kWh
```

### 6.2.5.12 Reset Total E

The total energy generated record can be cleared here, and after clearing, the energy generation record will be zero.

```
YES=ENT EXIT=ESC
Are You Sure?
```

Press ENT to clear the energy generation history and press ESC to cancel the previous operation.

### 6.2.5.13 Inverter On/Off

This function is to control the grid connection or disconnection of inverters.

```
Inverter ON/OFF
ON
```

Press UP/DOWN to scroll the menu, press ENT to perform the selection, and press ESC to return to the previous menu.

### 6.2.5.14 Export Limit

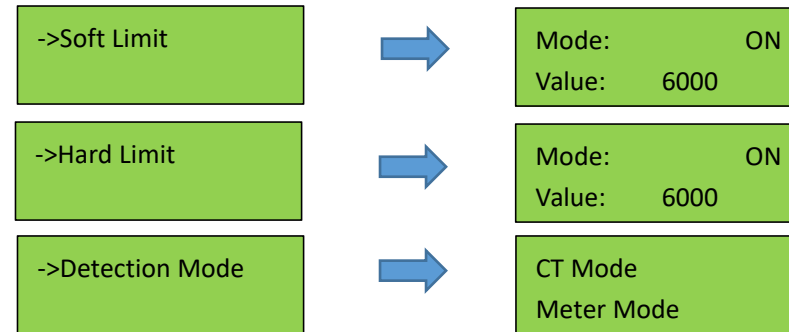

The inverter's export limit can be achieved together with external devices such as a CT or meter. There are two types of limit, soft limit and hard limit. The soft limit means that the limit is controlled by software, and hard limit means that if the generation exceeds the limit, the inverter will stop working. Under the detection mode menu, you can choose CT mode or meter mode. For the normal working of inverters, please use the soft limit only. The hard limit is used only by compulsory requirement of local grid companies.

## 7. Maintenance and Troubleshooting

### 7.1 General Maintenance

The Inverters do not need regular maintenance and just ensure that they are free of dust, foliage and other dirt.



**NOTE:** The use of cleaning agents may damage the machine and its components. Only use a cloth moistened with clear water to clean the machine.

## 7.2 Disposing of Inverters

If the inverters need to be disposed of, please do that according to the local regulations for electrical equipment waste, and choose the right site for the disposing specified for electrical equipment waste according to local regulations.

## 7.3 Storage and Transportation

If the inverters will not be installed in a short term, please store them in a dry room with the ambient temperature between -25~60 °C . For storage and transportation, please pack them in the original package if possible and stack inverters no more than 8 packs.

## 7.4 Troubleshooting

No.	Events	Explanation	Solutions
1	DC Volt Over	High voltage of PV input strings	<ol style="list-style-type: none"> <li>1. Check if the input voltage exceeds the inverter's upper limit of input voltage</li> <li>2. Decrease solar panels quantity in series</li> </ol>
2	DC Over Current Soft	PV current exceeds the software protection limit	<ol style="list-style-type: none"> <li>1. Restart the inverter</li> <li>2. Decrease solar panels quantity in parallel if it occurs repeatedly</li> </ol>

3	DC Over Current Hard	PV current exceeds the hardware protection limit	<ol style="list-style-type: none"> <li>1. Restart the inverter</li> <li>2. Decrease solar panels quantity in parallel if it occurs repeatedly</li> </ol>
4	Bus Over Voltage Soft	Transient bus voltage exceeds the software protection limit	<ol style="list-style-type: none"> <li>1. Check if the input voltage exceeds the inverter's upper limit of input voltage</li> <li>2. If not, restart the inverter</li> <li>3. If yes, decrease solar panel quantity in series</li> </ol>
5	Bus Over Voltage Hard	Transient bus voltage exceeds the hardware protection limit	<ol style="list-style-type: none"> <li>1. Check if the input voltage exceeds the inverter's upper limit of input voltage</li> <li>2. If not, restart the inverter</li> <li>3. If yes, decrease solar panel quantity in series</li> </ol>
6	Transient Over Voltage	Transient over voltage in grid	Restart the inverters
7	Inv Over Current Soft	Inverter software over current	<ol style="list-style-type: none"> <li>1. Restart inverters</li> <li>2. Decrease string in parallel</li> </ol>
8	Inv Over Current Hard	Inverter hardware over current	<ol style="list-style-type: none"> <li>1. Restart inverters</li> <li>2. Decrease string in parallel</li> </ol>
9	Island Protect	Island effect protection	<ol style="list-style-type: none"> <li>1. Check whether AC circuit breaker has been triggered off</li> <li>2. Check AC cables connection</li> <li>3. Check whether grid is not in service</li> <li>4. If the above reasons have been excluded and this fault still occurs in the LCD screen, contact the</li> </ol>

			installer
10	Low Temperature Inside Inverters	Low Temperature Inside Inverters	Check if the ambient temperature is below normal working temperature of inverters and increase ambient temperature
11	High Temperature Inside Inverters	High temperature inside inverters	1. Check the ventilation of installation environment 2. Avoid direct sunlight
12	Extern Flash	Abnormality in external flash reading and writing	Restart the inverter
13	Bus Unbalance	Bus Unbalance	Restart the inverter
14	Low bus voltage	Low bus voltage	1. Check if the input voltage is too low 2. If not, restart the inverter 3. If yes, increase solar panel quantity in series
15	Over Frequency	Export reduction due to over frequency	Adjust the protection value limit by user-designing function as permitted by grid company
16	Over Temperature	Export reduction due to over temperature	1. Check the ventilation of installation environment 2. Avoid direct sunlight

17	GFCI Device Fault	Fault in current leakage testing device	Restart the inverter or contact the installer
18	ACHCT Device Fault	Fault in HCT device on AC side	Restart inverter or contact the installer
19	GFCI Out Range	Current leakage is out of range	Check the AC connection and DC connection, and check internal wire connection
20	DCI Out Range	DC component is too large	Restart the inverter or contact the installer
21	ISO Out Range	The insulation impedance is too small	1. Remove all DC inputs, reconnect them one by one, and restart the inverter 2. Identify the string that causes the fault and check the insulation of the string
22	No Grid... Pls Turn On AC	No utility grid	1. Check the AC breaker 2. Check the connection of AC plug 3. Check whether the inverter's L, N, PE line have been connect with the corresponding grid L, N, E line correctly



23	Temp is Too High	Temperature is too high	<ol style="list-style-type: none"> <li>1. Check the ventilation of installation environment</li> <li>2. Avoid direct sunlight</li> </ol>
24	Temp is Too Low	Temperature is too low	Check if the ambient temperature is below normal working temperature of inverters and increase ambient temperature
25	PV Over Voltage	Over voltage in PV Inputs	<ol style="list-style-type: none"> <li>1. Check if the input voltage exceeds the inverter's upper limit of input voltage.</li> <li>2. Decrease solar panel quantity in series</li> </ol>
26	Grid Volt Over 110%	The grid is overloaded by 10% for over 10 minute	<ol style="list-style-type: none"> <li>1. Wait for the inverter to recovery</li> <li>2. If the impedance of AC cable is too small, replace it with a larger size cable</li> <li>3. Adjust the protection value limit as permitted by the grid company</li> </ol>
27	Grid Volt Out Range	Grid voltage is out of range	<ol style="list-style-type: none"> <li>1. If the impedance of AC cable is too small, replace it with a larger size cable</li> <li>2. Adjust the protection value limit as permitted by the grid company</li> </ol>
28	Grid Freq Out Range	Grid frequency is out of range	Adjust the protection value limit through self-designing function as permitted by the grid company

29	Relay Fault	Fault in grid-connection relay	Restart the inverter or contact the installer
30	MS Comm Fault	Communication fault between the main CPU and the slave CPU	Restart the inverter or contact the installer
31	Power to Grid beyond Limit	Power exported to Grid exceeds the Hardware Limit	<ol style="list-style-type: none"> <li>1. Turn on the software limit and set up a software limit that is lower than the hardware limit</li> <li>2. Turn off the hardware limit if permitted</li> </ol>
32	PEN No Connect	Grounding fault as the PE and N line has not been connected well	<ol style="list-style-type: none"> <li>1. Check the connection of the PE line and the N line</li> <li>2. Contact the installer</li> </ol>

**NOTE**

If any event in the above table is displayed, please turn off the inverter, wait 5 minutes and then restart the inverter.

## 8. Specification

Model	EES6KPro-M1	EES7K-M1	EES8K-M1	EES9K-M1	EES10K-M1
Series Name	EES-M1				
<b>DC Input</b>					
Recommended max. PV power	9KW	10.5KW	12KW	13.5KW	15KW
Max. input voltage	600 V				
MPPT voltage range	80V~580 V				
Max. input current/Max MPPT input current	18A/18A/18 A		18A/18A/36 A		
Max. short circuit current/Max MPPT short circuit current	22A/22A/22 A		22A/22A/44 A		
MPPT number	3				
String number per MPPT	1/1/1		1/1/2		
<b>AC Output</b>					
Rated Output Power	6KW	7KW	8KW	9KW	10KW
Rated/Max. apparent output power	6KVA/6KVA	7KVA/7KVA	8KVA/8KVA	9KVA/9KVA	10KVA/10KVA
Max. active power	6KW	7KW	8KW	9KW	10KW
Rated output current	26.0A	30.4A	34.8A	39.1A	43.5A
Max. output current	26.0A	30.4A	34.8A	39.1A	43.5A
Rated voltage/range (L/N/PE)	220 V/230 V/240 V / 180V - 300V				
Rated frequency	50 Hz / 60 Hz				
Power Factor	>0.99, 0.8 leading ~ 0.8 lagging				
THDi	<3%				
<b>Efficiency</b>					
Max. efficiency	98.60%				
EU efficiency	98.10%				
<b>Protection</b>					
Ground fault monitoring	Yes				
Output over voltage protection	Yes				
Anti-islanding Protection	Yes				
Integrated AFCI	Optional				
DC reverse-polarity protection	Yes				
Over voltage category	AC Class III/PV Class II				
<b>General Data</b>					
Dimension (W*H*D)	411*409*162 mm				
Shell material	Aluminium alloy				
Weight	14Kg				
Operating ambient temperature range	-25~60 °C				
Noise Emission	20 dB(A)				
Full load ambient temperature	45 °C				
Topology	Transformerless				
Ingress protection	IP66				
Cooling concept	Natural Convection				
Max. operation altitude	3000 m				
Grid connection standard	AS 4777.2:2020, EN50549-1:2019, G98:2021, G99:2021,NC RFG, PTPIREE, ABNT NBR 16149, ABNT NBR 16150,VDE-AR-N 4105, CEI0-21, RD1699				
Safety/EMC standard	IEC-62109-1/-2, IEC-62477-1/-2, IEC-61000-6-1/-2/-3, NB/T32004				
Country of manufacturing	China				
DC connection	MC4/D4				
Communications	Wifi(2.4G), GPRS, 4G, Bluetooth, RS485				